

PRODUCT FEATURES

- Line Voltage 220–240V – No Driver Required
- Easy and Quick Snap Connection
- Innovative Slim Design
- Seamless and Spot Free
- Line Voltage Phase Dimming
- Compatible with Trailing Edge Dimmer Only
- Flicker Free
- Various accessories option

PRODUCT SPECIFICATIONS

- Voltage : AC 220–240V
- Operating Temperature : 0–45°C (32–113°F)
- Lamp Life : 50,000hr / 70%
- Available Color : 2700K, 3000K, 3500K, 4000K
- Color Rendering : CRI>90
- Beam Angle:130°
- 3 year warranty

MAX. CONNECTION

- 400W in one row (single power feed)

DIMENSIONS

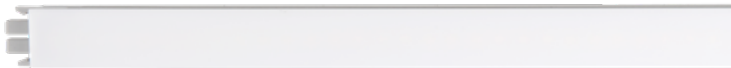

NDF3 / FLX Stix NDFree 3W length 156mm(6.1")

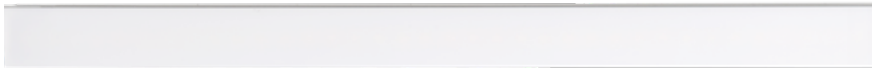

NDF5 / FLX Stix NDFree 5W length 291.5mm(11.5")

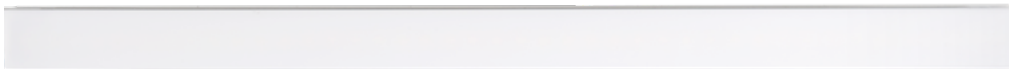

NDF10 / FLX Stix NDFree 10W length 569.5mm(22.4")

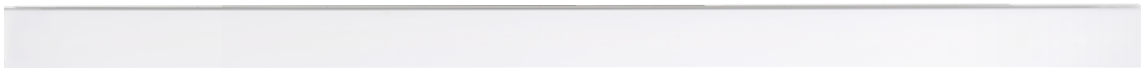

NDF15 / FLX Stix NDFree 15W length 848mm(33.4")

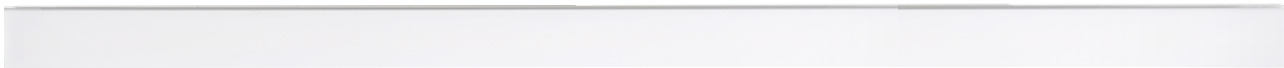

NDF20 / FLX Stix NDFree 20W length 1,126mm(44.3")



Model Number	Voltage Input (V)	Lamp Power (W)	Lumens(lm) (CRI90)	A mm (inches)	B mm (inches)	C mm (inches)	D mm (inches)	E mm (inches)	F mm (inches)	G mm (inches)
NDF3-(Color)K-230V-C90	AC 220–240V	2.5	212	147 (5.8)	156 (6.1)	178.7 (7)	19 (0.75)	18 (0.71)	18 (0.71)	16.8 (0.66)
NDF5-(Color)K-230V-C90	AC 220–240V	5.34	340	282.5 (11.1)	291.5 (11.5)	314 (12.4)	19 (0.75)	18 (0.71)	18 (0.71)	16.8 (0.66)
NDF10-(Color)K-230V-C90	AC 220–240V	10.93	720	560.5 (22)	569.5 (22.4)	592 (23.3)	19 (0.75)	18 (0.71)	18 (0.71)	16.8 (0.66)
NDF15-(Color)K-230V-C90	AC 220–240V	16.08	1,080	839 (33)	848 (33.4)	870.5 (34.3)	19 (0.75)	18 (0.71)	18 (0.71)	16.8 (0.66)
NDF20-(Color)K-230V-C90	AC 220–240V	21.3	1,440	1,117 (43.4)	1,126 (44.3)	1,148.5 (45.2)	19 (0.75)	18 (0.71)	18 (0.71)	16.8 (0.66)

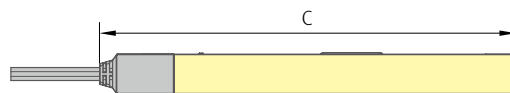
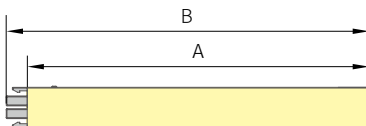

w/bracket

* LED 90° Connector
NDF3 40K-230V-C90-90

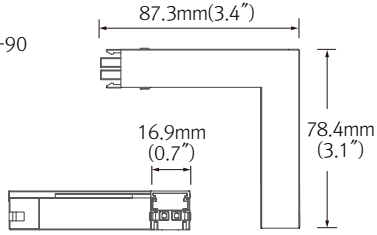

* NDF ON/OFF Switch

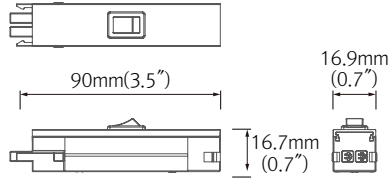

* LED Power Cord
NDF3 40K-230V-C90-PC / OPC

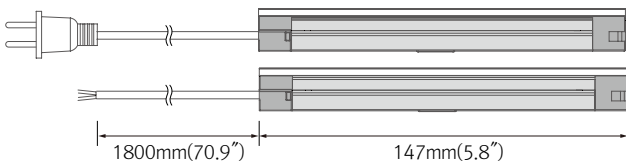

* 90 degree connector for NDF-EXL

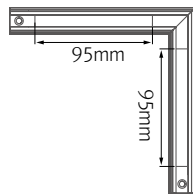

* Flexible Connector

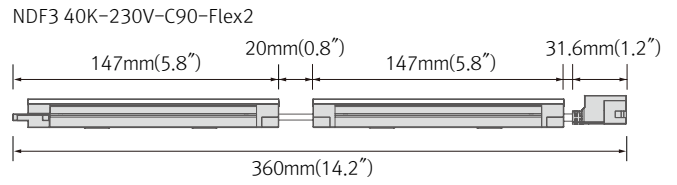

NDF3 40K-230V-C90-Flex3

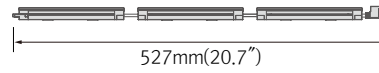

NDF3 40K-230V-C90-Flex5

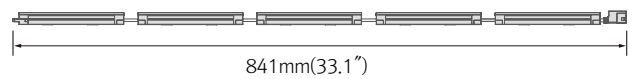

* NDF PENDANT

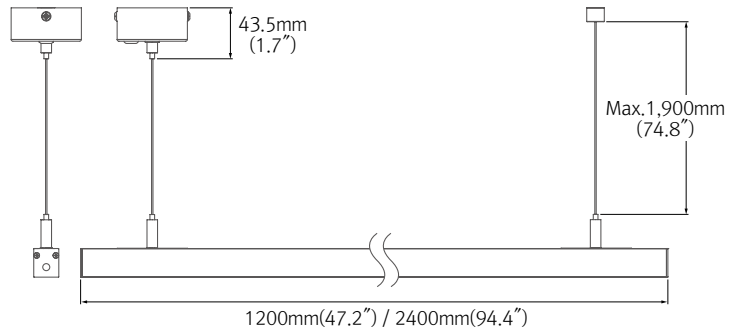

* NDF Extrusion Line



BEAM SPREADS

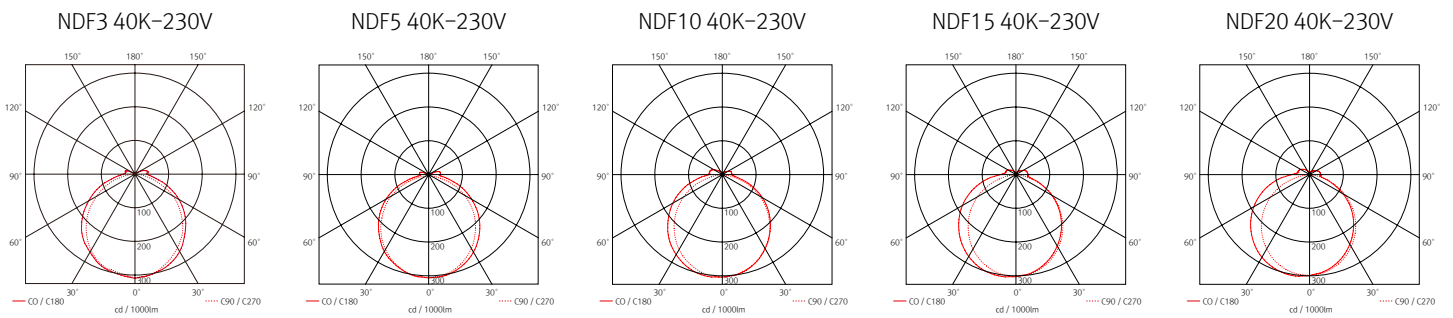

EASY CONNECTION

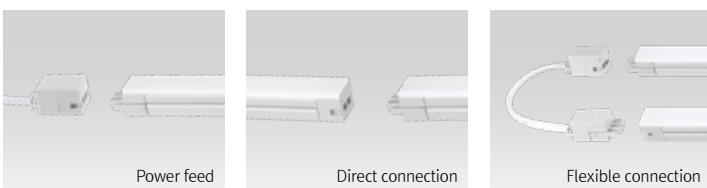

VARIOUS OPTIONS



INSTALLATION

☆Before Installation(Power Connection)

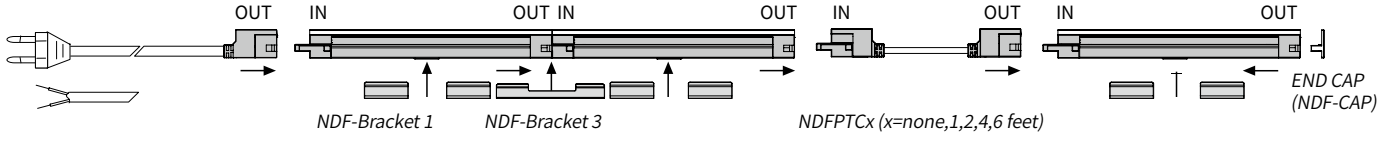

☆After Installation

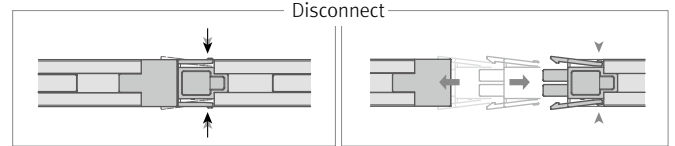
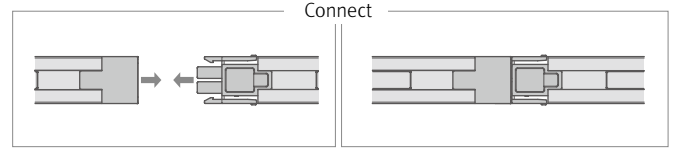
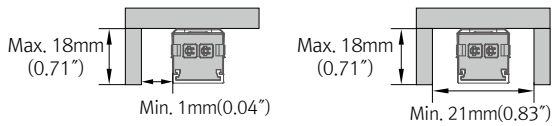
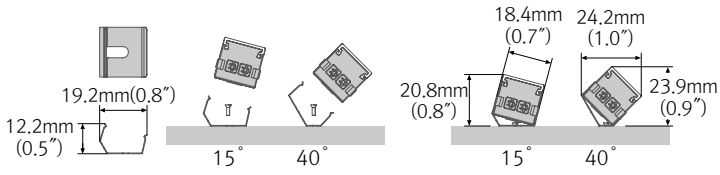
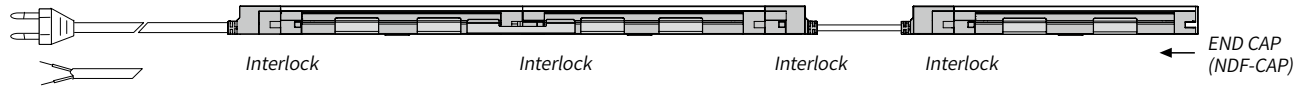

* When you disconnect NDF, please push the connector button and pull-out fixtures.

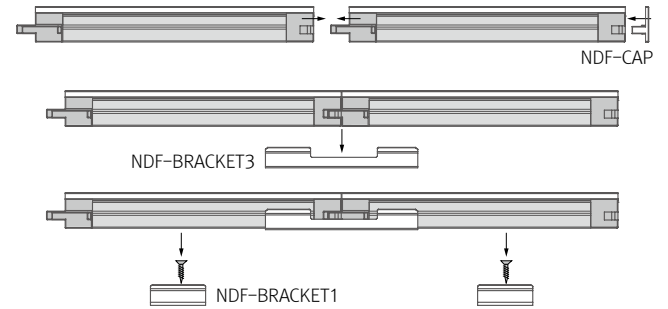

☆Pendant Installation

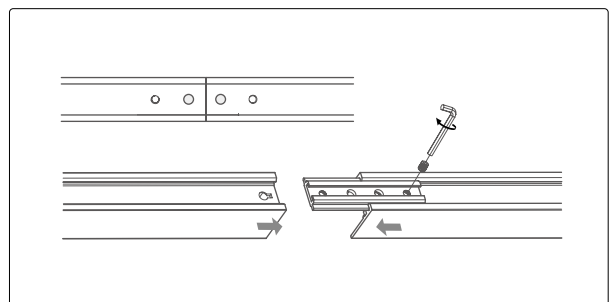
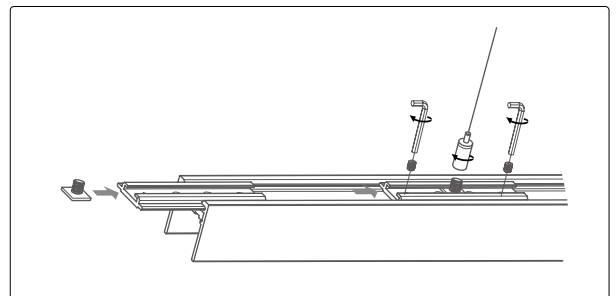
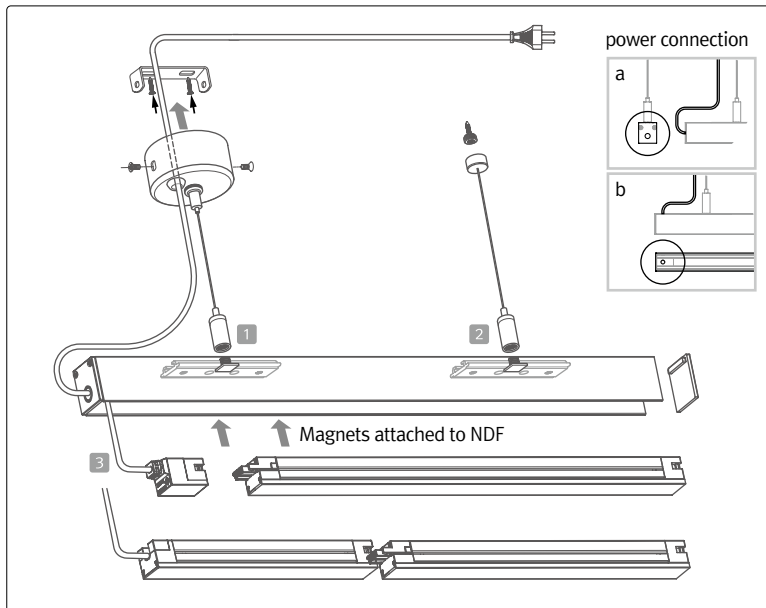

COMPONENTS



LED Power connector
 __NDF3-(Color)K-230V-PC
 NDF3 (150mm) fixture with
 1,800mm power cord



Power Cord
 __NDFPC/T (1,800mm)



Mounting Bracket
 __NDF-BRACKET1
 Included with fixture

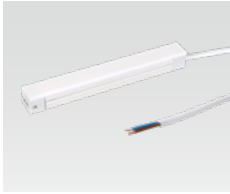

LED open power connector
 __NDF3-(Color)K-230V-OPC
 NDF3 (150mm) fixture with
 1,800mm open power cord

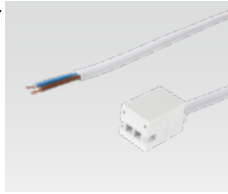

Open Power Cord
 __NDFOPC/T (1,800mm)



Angle bracket
 __NDF-BRACKET2



LED 90° Connector
 __NDF3-(Color)K-230V-90



Connecting Cable
 __NDFPTC/T (150mm)
 __NDFPTC1/T (300mm)
 __NDFPTC2/T (600mm)
 __NDFPTC4/T (1,200mm)
 __NDFPTC6/T (1,800mm)



Connecting bracket
 __NDF-BRACKET3
 Included with fixture



Flexible Connector
 __NDF3-(Color)K-230V-Flex2
 (359.5mm)
 __NDF3-(Color)K-230V-Flex3
 (521.5mm)
 __NDF3-(Color)K-230V-Flex5
 (830.5mm)



Extrusion End Cap
 __NDF-EXL-CAP
 Included with Track



Suspension bracket
 __NDF-SK-BRACKET
 Suspension Bracket for NDF



On/Off Switch
 __NDF-SW



NDF Extrusion line
 __NDF-EXL (1.2m)
 __NDF-EXL (2.4m)



Suspension Power Kit
 __NDF-SK-POWER
 Suspension Power Kit
 for NDF



**90 degree connector for
 NDF-EXL**
 __NDF-EXL-90



Extrusion Joint Bracket
 __NDF-JOINT BRACKET



**Dimming Interface
 (Bluetooth)**
 __FDS-H1B-SR
 Max. 200W (100W/CH,1CH)



**Dimming Interface
 (Dail)**
 __FDS-H1DA-SR
 Max. 200W (200W/CH,1CH)



**Dimming Interface
 (Dail)**
 __FDS-H2DA-SR
 Max. 288W (144W/CH,2CH)